

uDiRC

U66 USER MANUAL

Suitable for indoor flight

- ▲ This product is suitable for users over 14 years old.
- ▲ Stay away from the rotating propeller
- ▲ Read the <important statement and safety guidelines > carefully.

Ready Before Take Off

Drone preparation

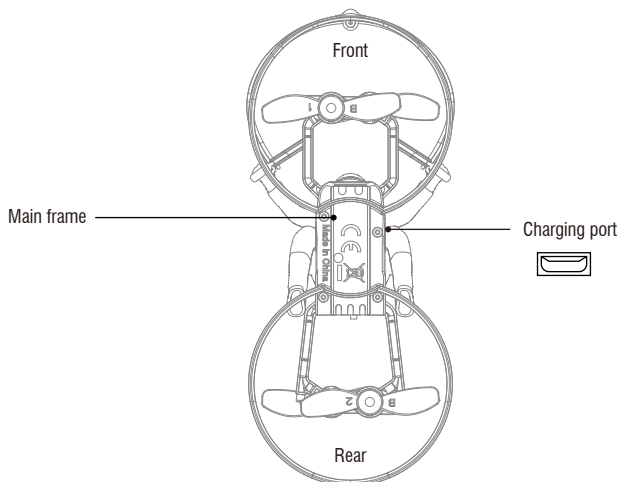
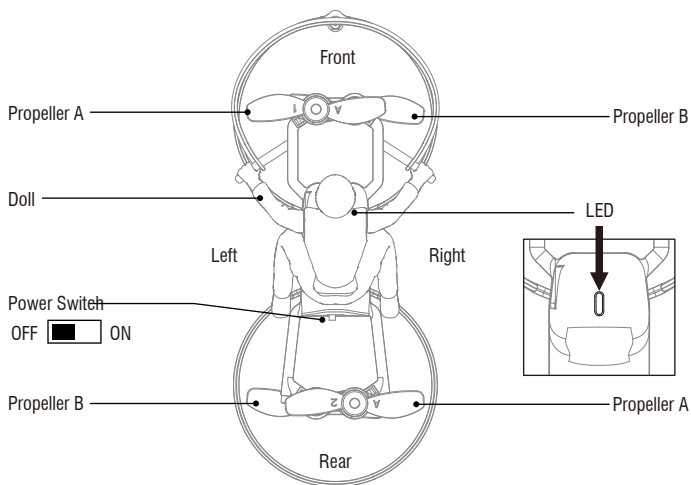

Slider drone doll installation

Installation: aim the doll buckle at the main body buckle, press down the doll's hand to the main body handle vertically.

Disassembly: hold the doll and lift out.

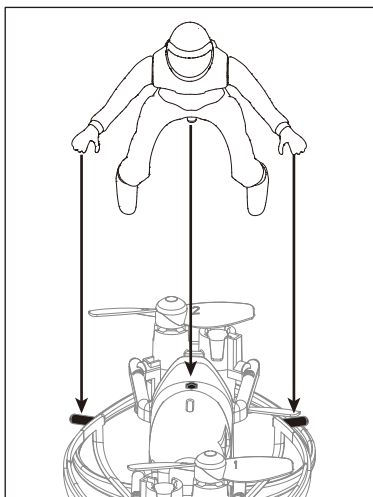

Charging Instruction

Battery power is insufficient in the original plant. It must be charged saturated before it can be used.

Connect the original charging cable with the drone, and then connect other USB charging port. The drone red LED keeps bright when charging and the light turns green when fully charged. The drone power button should be turned off when charging.

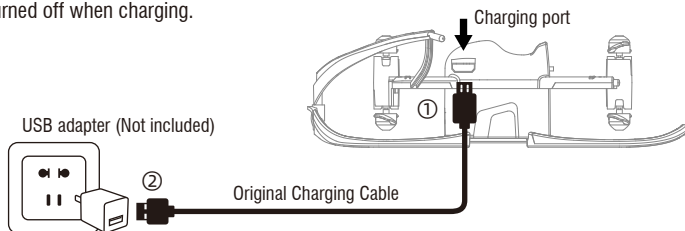

▲ Only use the original charging cable; suggest select Adapters with output current of 5V 2A .

Transmitter preparation

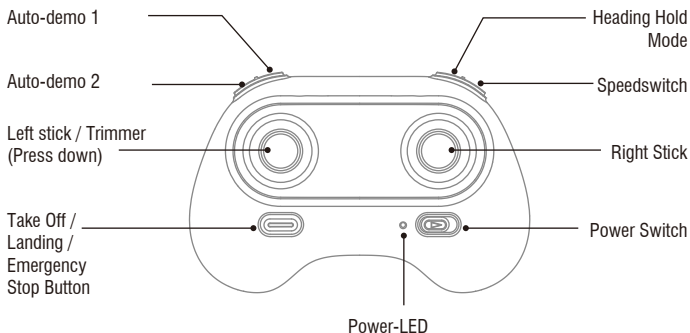

Battery installation

Open the battery cover on the back side of the transmitter, according to the "+-" electrode instruction in the battery groove, place the battery with the same type of saturated power (battery not include).

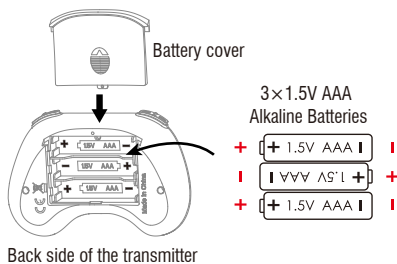

Flight Operation

Transmitter connect with Drone

Frequency Pairing

- ① Power on the drone, the drone LED will change from fast flash to slow flash, and enter frequency pairing.



- ② Turn on the power on the transmitter, the power-LED will flash quickly.

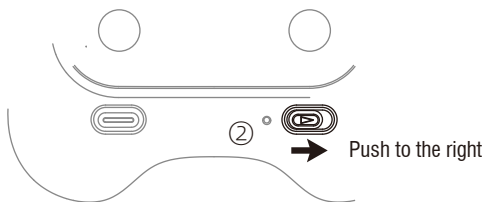

- ③ Pull the left stick until bottom and then release, and the transmitter power-LED will keep bright and sound beep to show frequenc pairing successful.

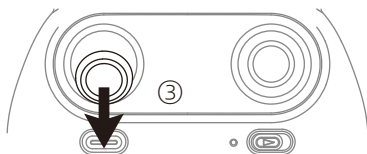

Control stick operation

Left stick

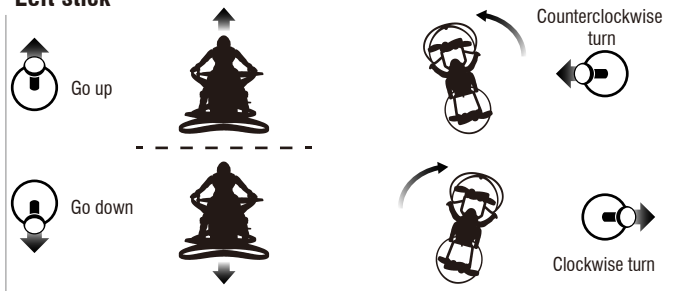

Right stick

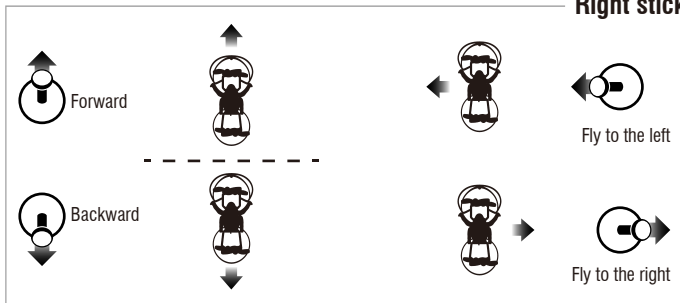

Take off

After the frequency pairing is successful, press the "take off/land" button, the transmitter will sound "di", and the drone will automatically rise and fly at an altitude of about 1.2 meters.

Landing

During the flight, press the "take off/land" button, the transmitter will sound "di", and the drone will land slowly until landing.

Don't operate the left stick during landing, otherwise the current command will automatically fail.

Emergency Stop: During the flight, press "take off/land" button for about 2 seconds, the transmitter will sound "di.di..." and the drone crashes directly.

Tip: Do not use the emergency stop function unless in emergency situation.

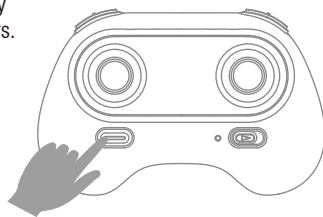

Auto-demo 1

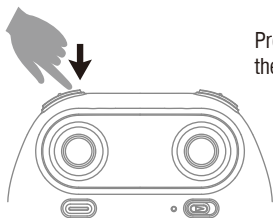

Press the "Auto-demo 1" button, the drone will rotate 720°.



Auto-demo 2

Press the "Auto-demo 2" button, the drone fly forward, turn back and return to take off point.

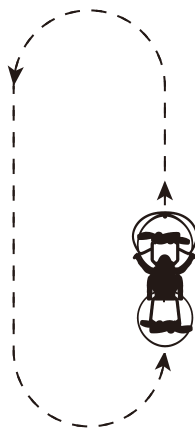
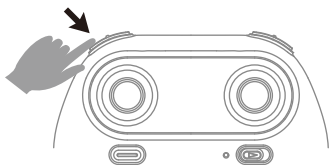

Speed mode switch

Press the "H/L" button, the transmitter will sound "di.di.di", to enter High Speed Mode "H".
Press again, the transmitter will sound "di", to enter Low Speed Mode "L".
Press again, the transmitter will sound "di.di", to enter Middle Speed Mode "M".

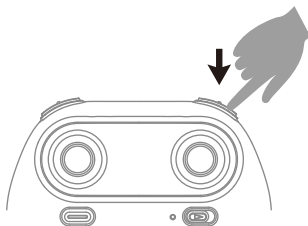

Medium speed default

Low speed: suitable for beginners to practice without wind.

Medium speed: suitable for skilled operator operating in light breeze.

High speed: suitable for professional operation in outdoor wind resistance.

Heading Hold Mode

The default setting is NOT Heading Hold Mode.

Heading Hold Mode means that the user can operate the aircraft without having to distinguish directions. This mode is suitable for beginners, or when it is difficult to distinguish the forward and backward direction of the drone.

- ① The Heading Hold Mode needs to ensure that the front of the drone is consistent with the front of the controller, the controller does not change the direction of the transmitter, and the drone is always in front of the controller.
- ② When the front of the drone is not consistent with the pilot's front, the drone will lose control or be lost.

Start: press the "Heading Hold Mode" button, the transmitter will sound "didi" to enter the Heading Hold Mode.

Off: press again, the transmitter will sound "didi" to exit the Heading Hold Mode.

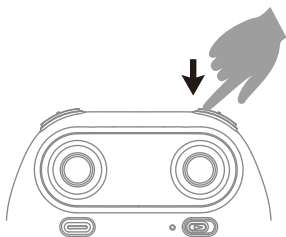

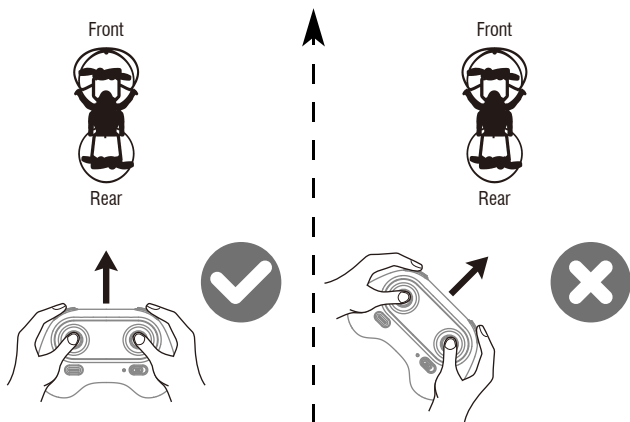

Flying Trimmer

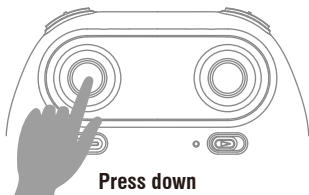

Forward / Backward Trimmer

During the flight, if the drone tilts forward, press down the left stick in the center button, and push the right stick backwards. Otherwise push forwards.

Left and right turning trimmer

During the flight, if the drone head rotates to left, then press down the left stick in the center button and push the left stick to right. Otherwise push to left.

Left and right side flying trimmer

During the flight, if the drone tilts to left, then press down the left stick in the center button and push the right stick to right to adjust. Otherwise push to left.

Drone calibration (When abnormal flying)

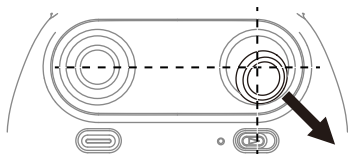

After successful frequency alignment, the right stick is pushed to the lower right corner by 45°, and the drone LED turns to keep bright after quick flashing, indicating that the gyroscope has been calibrated. Release the right stick.

Tips: When the drone is fiercely impacted or crashed, it may cause the gyro can not recover and cause difficult control, if so, you can re-pairing&re-calibrate and put the drone on the level surface.

Unlocking/locking the motor

Push the left and right stick inward to the 45 degree angle simultaneously.

- ① In standby, unlocked the motor and working.
- ② In Working, locked the motor and stop rotating.

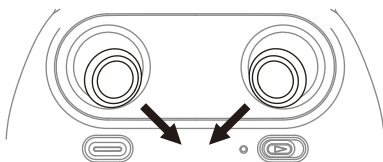

Altitude Hold Mode

Intelligent flight control system calculates the hovering position, more stable control feature, makes it easier for beginners to control. Release the stick, the drone will keep hovering automatically to enable single hand operation.

Note: If the propeller is deformed or damaged, Altitude Hold Mode will fail.
If the atmospheric pressure is instability or Typhoon weather, Altitude Hold Mode can not work well.

Low Battery Alarm

When the transmitter in low battery, the transmitter will continues to sound “di-di” to remind the user to return home and replace the batteries of the transmitter as soon as possible.

When the drone in low battery, the drone LED will continue to “flash and stop”, the drone must return home at this time.

Stuck Protection

1. When the propellers get stuck, then activate stuck protection function and the motors stop running.
2. Pull down the left stick to the lowest position and then go back to the center, stuck protection will be released and the drone can fly again.

Parts Replacement

Propeller Replacement

To remove the propeller, hold the propeller vertically and then pull the propeller out.
To install the propeller, mount propeller aim the central shaft of the motor and press down.

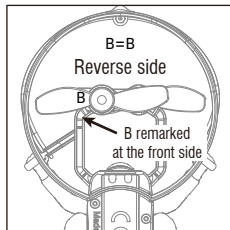
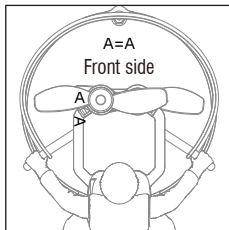
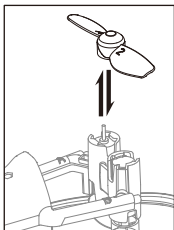

There is different A and B remarks on the propeller. Be sure that the propellers are installed to the correct motors, which remarked the Letters to identify on the motor holder, if not, then the drone can not work normally.

Attention

- ① Switching sequence. At first, turn on the power of the drone, then turn on the power of the transmitter. After the end, turn off the power of the drone first, and then turn off the power of the transmitter.
- ② Improper operation caused the crash. It is necessary to check and confirm the connection of the motor, propeller or battery of the drone and the damage degree, so that the drone can fly again. If there is damaged, please replace the new accessories or prone to accident.

Parameter

Drone

Weightht	28g (typical value)
Propeller Diameter	38mm
Maximum flight time	8 minutes(calm)
Operating Temperature Range	0°C to 40°C
Operating frequency	2.4GHz
Battery	3.7V , 220mAh
Type of battery	LiPo
Charging Time	About 40 minutes
Charging temperature range	5°C to 40°C

Transmitter

Operating frequency	2.4GHz
Maximum transmission distance	20m (no interference and barrier-free)
Operating temperature	0°C to 40°C
Battery	3×1.5V AAA battery

Charger

Output	5V === 2A
--------	-----------

Tips: the above data are the test data of UDIRC toy lab, for reference only.

Troubleshooting

NO.	Problem	Problem cause	Solution
1	The controller Indicator light is off.	Low battery.	Replace the controller battery.
		The batteries are incorrectly.	Install the batteries following the polarity indicators.
		The batteries are incorrectly positioned.	Clean the dirt between the battery and the battery contacts.
2	Failed to pair the drone with the controller.	Indicator light is off.	The same as above.
		There is an interfering signal nearby.	Restart the drone and power on the controller.
		Mis-operation.	Operate the drone step by step in accordance with the user manual.
		The electronic component is damaged for fiercely crash.	To buy spare parts from local seller and replace damaged parts.
3	The drone is under-powered or can not fly.	The propeller is seriously deformed.	Replace the propeller.
		Low battery.	Charge the drone battery.
		Incorrect installation of propeller.	Install the propeller in accordance with the user manual.
4	The drone could not hover and tilts to one side.	The propeller is seriously.	Replace the propeller.
		The motor holder is deformed after violent crash.	Replace the motor holder parts.
		The gyroscope did not reset after a serious crash.	Put the drone on the flat ground for about 10 minutes or restart the drone to calibrate again.
		Motor is damaged.	Replace the motor.
5	The drone indicator light is off.	Low battery.	Recharge the drone battery.
		The battery is expired or over discharge protection.	Buy a new battery from local seller to replace the battery or charge the battery.



Drone Battery Li-Po Battery Disposal & Recycling

Wasted Lithium-Polymer batteries must not be placed with household trash. Please contact local environmental or waste agency or the supplier of your model or your nearest Li-Po battery recycling center.



Important Notice

Our company's products are improving all the time, design and specifications are subject to change without notice.

All the information in this manual has been carefully checked to ensure accuracy, if any printing errors, our company reserve the final interpretation right.

FCC Note

This equipment has been tested and found to comply with the limits for a Class B digital device, pursuant to Part 15 of the FCC Rules. These limits are designed to provide reasonable protection against harmful interference in a residential installation. This equipment generates uses and can radiate radio frequency energy and, if not installed and used in accordance with the instructions, may cause harmful interference to radio communications. However, there is no guarantee that interference will not occur in a particular installation. If this equipment does cause harmful interference to radio or television reception, which can be determined by turning the equipment off and on, the user is encouraged to try to correct the interference by one or more of the following measures:

- Reorient or relocate the receiving antenna.
- Increase the separation between the equipment and receiver.
- Connect the equipment into an outlet on a circuit different from that to which the receiver is connected.

WARNING: Changes or modifications not expressly approved by the party responsible for compliance could void the user's authority to operate the equipment.

FCC Notice:

The equipment may generate or use radio frequency energy. Changes or modifications to this equipment may cause harmful interference unless the modifications are expressly approved in the instruction manual. Modifications not authorized by the manufacturer may void user's authority to operate this device.

This device complies with Part 15 of the FCC Rules. Operation is subject to the following two conditions:

- (1) This device may not cause harmful interference.
- (2) This device must accept any interference received, including interference that may cause undesired operation.

FCC Radiation Exposure Statement

The device has been evaluated to meet general RF exposure requirement. The device can be used in portable exposure condition with out restriction.



MADE IN CHINA