

UD1018

OPERATION GUIDE

Suitable for sailing in larger waters

Note

- ▲ This product is suitable for users over 14 years old.
- ▲ Stay away from the rotating propeller
- ▲ Read the “important statement and safety guidelines” carefully.
<https://udirc.com/disclaimer-and-safety-instructions>



Li-Po Battery Disposal & Recycling

Wasted Lithium-Polymer batteries must not be placed with household trash. Please contact local environmental or waste agency or the supplier of your model or your nearest Li-Po battery recycling center.



Important Notice

Our company's products are improving all the time, design and specifications are subject to change without notice. All the information in this manual has been carefully checked to ensure accuracy, if any printing errors, our company reserve the final interpretation right.

Ready before sailing

Preparation the boat

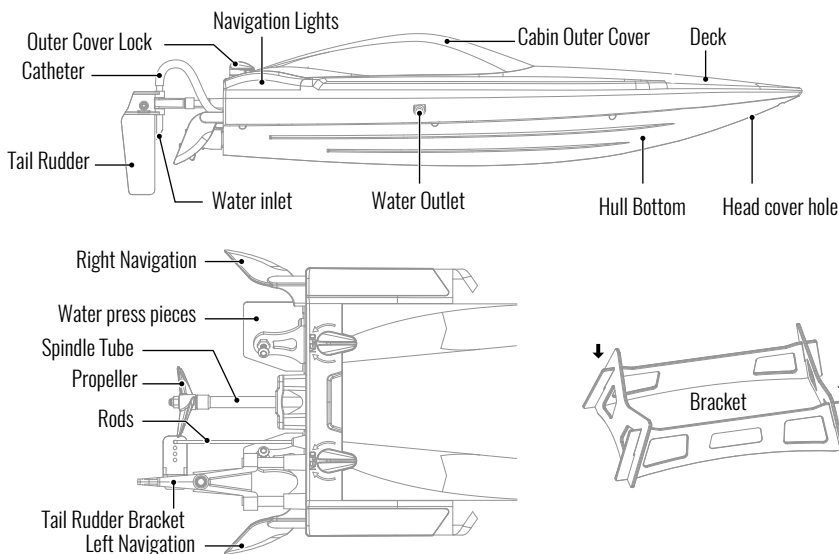

Boat battery Charge

The battery of the original boat model is insufficient, so it must be charged and saturated before use.

Connect the original charge with charge plug first and then connect the balance charge, finally connect the boat battery. And balance charge "CHARGER" "POWER" light keeps bright when charging. And the "CHARGER" light turns off and "POWER" light keeps bright when fully charged. Battery should not be placed in the hull when charging. The battery must be cooled before charging.

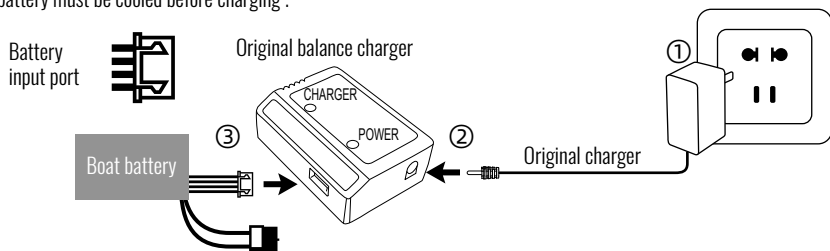

Warning: Must be supervised while charging

Please use the included USB charging cable and make sure it is properly connected.

Boat Battery Installation Method

1) Twist to left or right to open the outer cover lock.

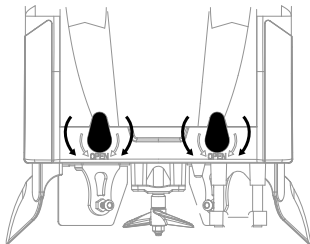

2) open up the cabin cover.

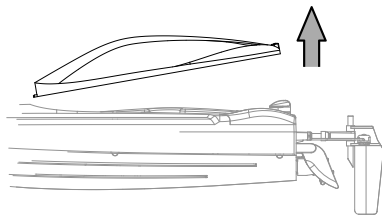

3) According to the mark on the surface of the inner cover, unlock the lock and take out the inner cover upward.

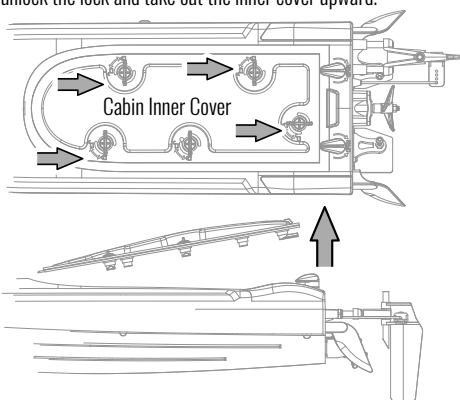

4) Put the Lipo battery into the boat battery holder.

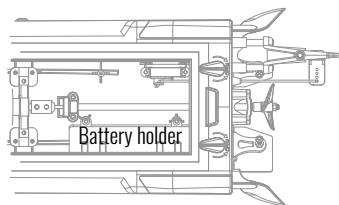

5) Then use velcro tape to fasten the battery is OK.

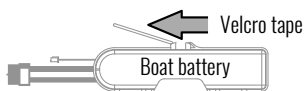

6) Properly connected the hull input port to the output port of the Boat battery.

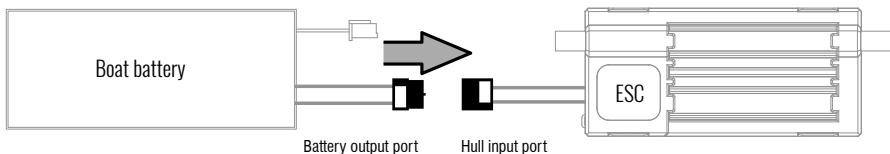

7) Install the inner-cover, outer-cover to the hull and then tighten the inner cover lock.

Notice:

- The Lipo battery wires need to put aside of the boat to avoid tangled or broken off by the rudder wheels.
- If there is a few boats to play together, you need to code pairing one by one, and can not do it at the same time to avoid improper operation and cause danger.

Head Cover Installation

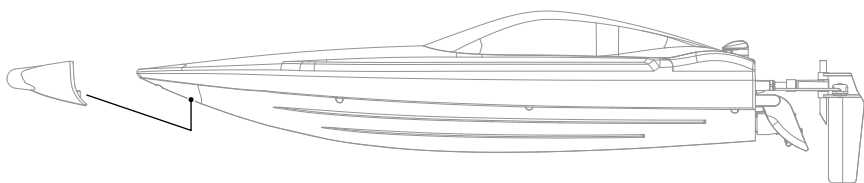

Align the head cover with the bottom hole of the boat and install it in the right place.

Transmitter Preparation

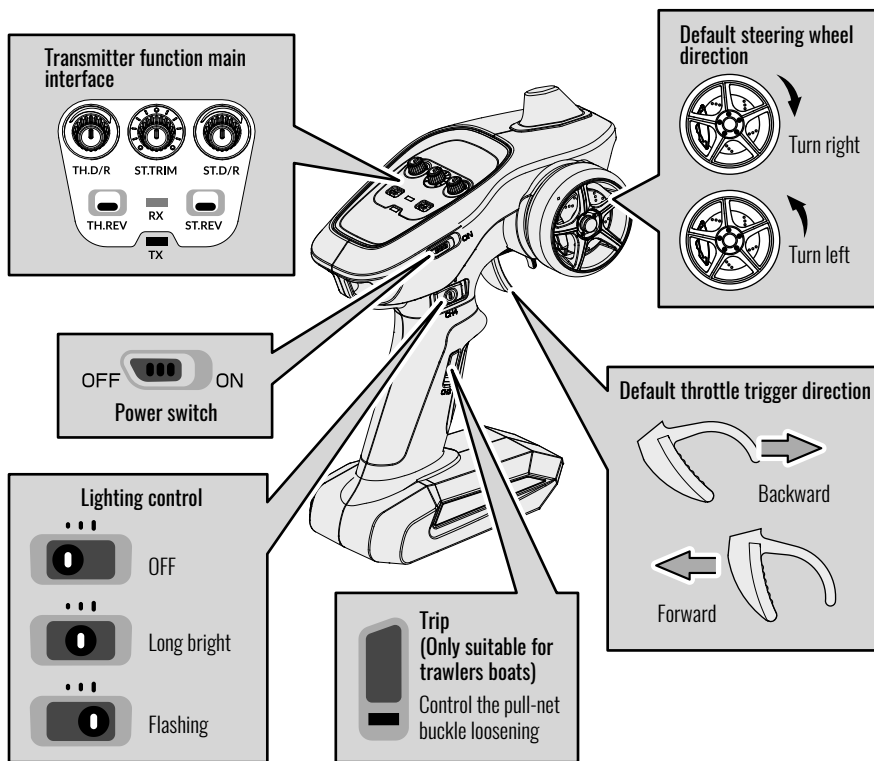

Battery installation of transmitter

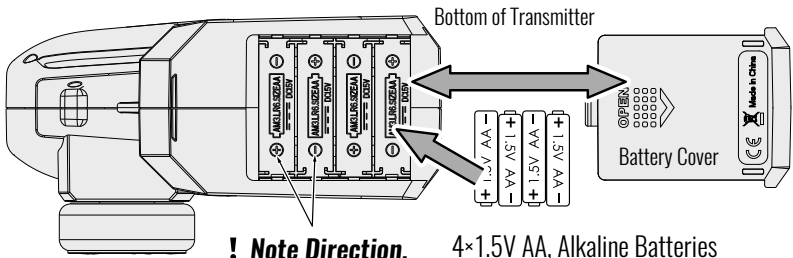

Open the transmitter battery cover. Install batteries. Follow the direction of batteries designated in the inside of the battery box.

Manipulation method

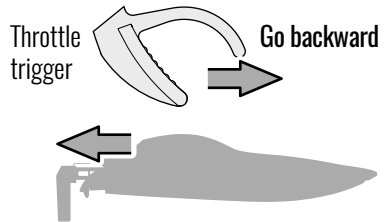
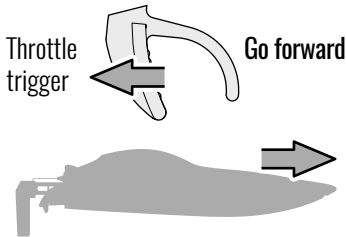

Turn left

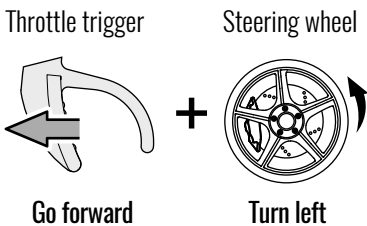

Turn right

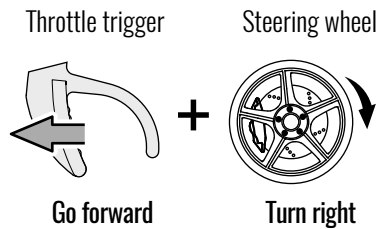

Low speed

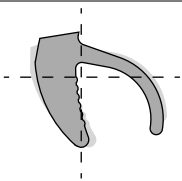

Pull the throttle trigger back gently and the car will move forward slowly.

High speed

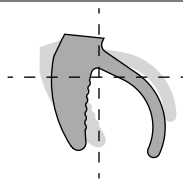

The throttle trigger is pulled to the maximum, and the car moves forward quickly.

Self-Righting Hull

If the boat capsizes, Push forward and backward the throttle trigger of the transmitter and then pull back at once. The boat will then return to normal, the capsize reset function will turn off automatically when the boat is in low battery.

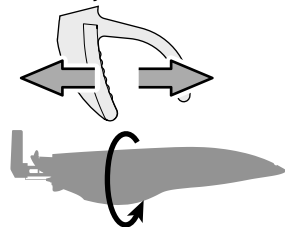

Introduction of main interface function

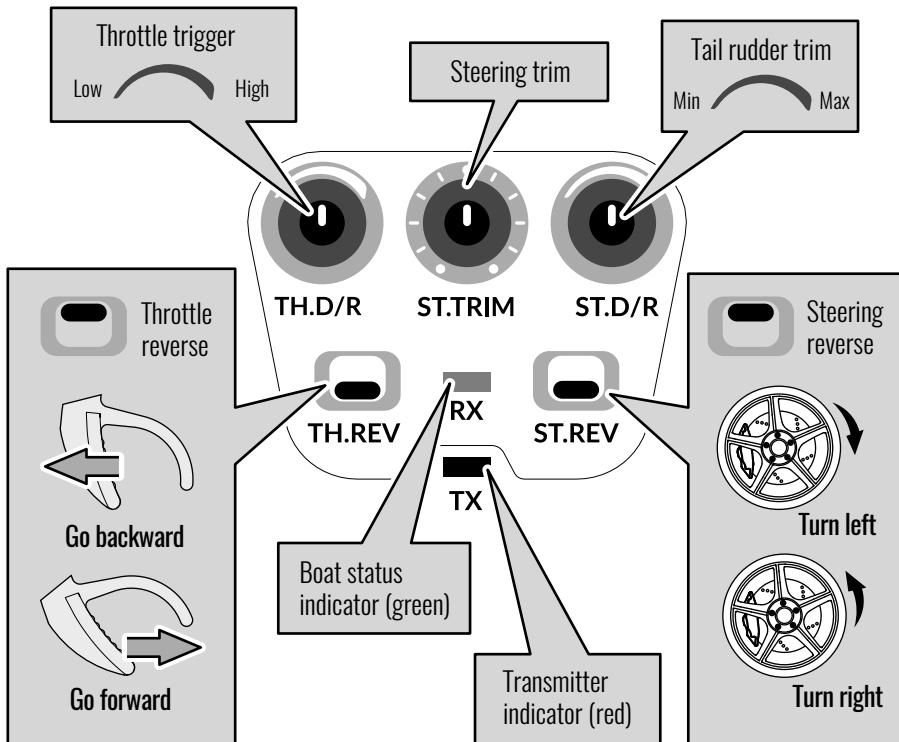

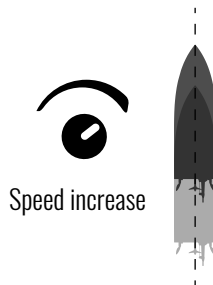
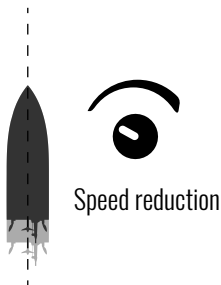

Throttle speed adjustment knob can be used to adjust the acceleration of the model.

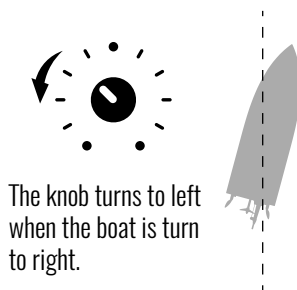
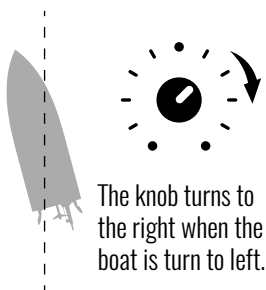

When the steering wheel is in the center position, if the model cannot sail in a straight line, please use the steering adjustment knob to adjust the left and right direction of the hull.

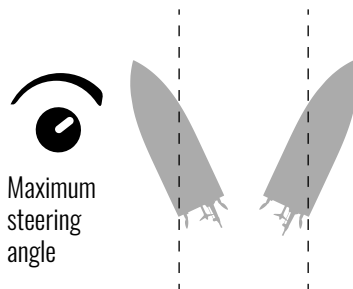
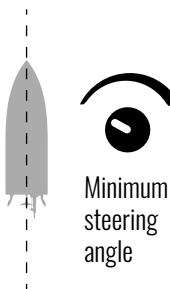

You can used the steering amplitude adjustment knob to adjust the left and right steering Angle of the ship model.

Frequency matching

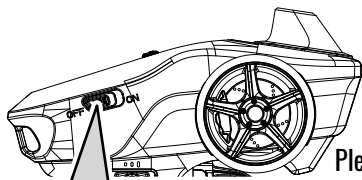

Do not touch the throttle trigger when turning on the power of the transmitter.

Please make sure the transmitter throttle trigger and Steering wheel to normal.

- 2) Connected the boat battery, the transmitter will sound "didi", it means frequency pairing successful.
- 3) Tighten the hatch cover.

It is recommended to be familiar with the operation on the surface of the water before long distance navigation.



1) Power on the transmitter, will sound "di", and the red indicator light flashes, then to enter frequency pairing.

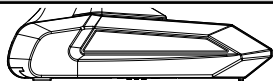

Check before sailing

- 1) Check the rotation direction of propeller once power on. Pull back the throttle trigger of transmitter slowly, the propeller will spin counterclockwise. Push forward the throttle trigger slowly, the propeller will spin clockwise.
- 2) Don't fold the water-cooling hose and keep it smooth inside.
- 3) Twist the rudder knob towards counterclockwise, the steering gear will turn left; Twist the Rudder Knob clockwise, the steering gear will turn right.
- 4) Make sure that the boat cover is locked up and buckled.

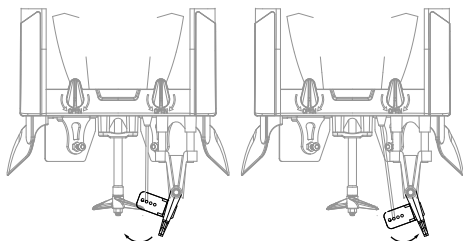

Turn left

Turn right

Low Battery Alarm

Boat: When the boat in low battery, the transmitter will beep "di.di.di. ...", and the green indicator flashes quickly, to remind the user to remote back the boat as soon as possible. And the boat speed will slow down and the capsizing reset function will turn off automatically when the boat in low battery.

Transmitter: When the transmitter in low battery, the red indicator flashes slowly to remind the user to remote back the boat to replace the batteries as soon as possible.

Out of Range Alarm

When the boat is running out of the max remote control distance, the transmitter will beep "didi...didi...", and the red indicator flashes slowly to alarm the user to remote back the boat immediately.

Water cooling system

The motor lowers the temperature by flowing water. During the voyage, water flows through the heat pipe around the motor, which has a cooling effect on the motor.

Safety Precautions

- 1) Turn on the transmitter power first and then turn on the boat power before playing; Turn off the boat power first and then turn off the transmitter power when finish playing.
- 2) Make sure the connection is solid between battery and motor etc. The ongoing vibration may cause bad connection of power terminal.
- 3) Improper operation may cause impact to the boat and damage the hull or propeller.
- 4) It is forbidden to sail in the water where people are useful and sail away from salt water and sundry water.
- 5) The battery must be take out after playing to keep the cabin dry and clean.

Parts Replacement

Propeller Replacement

Remove:

Disconnect the power of boat and hold the propeller fasteners, Unscrew the anti-skid nut counterclockwise to remove the propeller.

Installation:

Install the new propeller and tighten the anti-skid nut clockwise after the notch position fits the fastener.

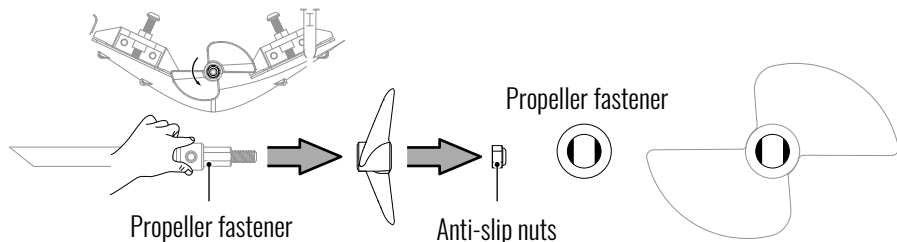

Replacement the Steel Rope

Remove: Remove the propeller, unscrew the propeller fastener and steel rope fastener used a hex wrench and then draw out the steel rope.



Installation: Replace the new steel rope, the installation step is opposite to the removal step.

Noted: When the propeller is entangled with debris, the steel rope is easy to burst. Please be sure to avoid debris in the water. The replacement of steel rope must be carried out with the battery power cut off.

Replac the steering gear

Disassembly : Turn off the power of boat

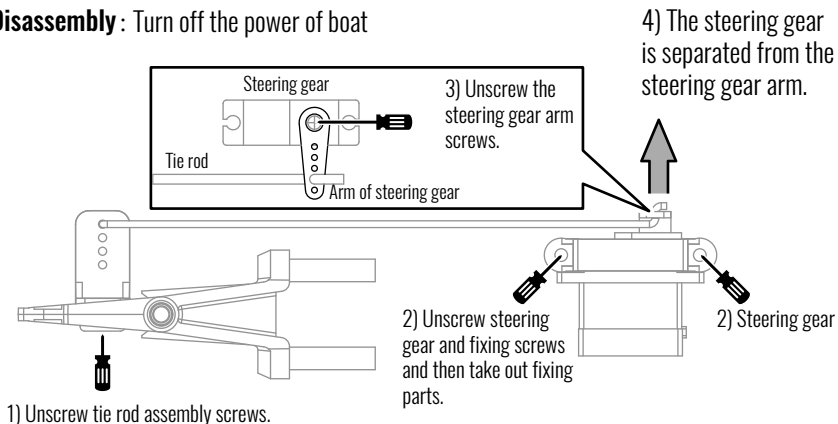

Installation : When the new steering gear is powered on, the installation should be conducted in the direction of disassembly sequence.

Replace the steering gear with powered on, please noted the propeller turns unexpectedly.

Troubleshooting Guide

Problem	Solution
The transmitter indicator light is off	1) Replace the transmitter battery.
	2) Please make sure the battery is installed correctly.
	3) Clean the dirt from metal contacts in battery groove.
	4) Please make sure turn on the power.
Unable to frequency	1) Operate the boat step by step in accordance with the user manual.
	2) Make sure signal interference nearby and keep away.
	3) The electronic component is damaged for frequent crash.
The boat is under-powered or can not go forward	1) Make sure whether the propeller is damaged or replace a new one.
	2) When the battery is low, charger it in time. Or replace it with a new battery.
	3) Make sure install the propeller correctly.
	4) Make sure whether the motor is damaged or replace a new one.
The boat tilts to one side	1) Operate according to the “trimmer” as per instructions.
	2) Calibrate the steering gear arm.
	3) The steering gear is damaged, replace a new one.

FCC Note

This equipment has been tested and found to comply with the limits for a Class B digital device, pursuant to Part 15 of the FCC Rules. These limits are designed to provide reasonable protection against harmful interference in a residential installation. This equipment generates uses and can radiate radio frequency energy and, if not installed and used in accordance with the instructions, may cause harmful interference to radio communications. However, there is no guarantee that interference will not occur in a particular installation. If this equipment does cause harmful interference to radio or television reception, which can be determined by turning the equipment off and on, the user is encouraged to try to correct the interference by one or more of the following measures:

- *Reorient or relocate the receiving antenna.*
- *Increase the separation between the equipment and receiver.*
- *Connect the equipment into an outlet on a circuit different from that to which the receiver is connected.*

WARNING: Changes or modifications not expressly approved by the party responsible for compliance could void the user's authority to operate the equipment.

FCC Notice

The equipment may generate or use radio frequency energy. Changes or modifications to this equipment may cause harmful interference unless the modifications are expressly approved in the instruction manual. Modifications not authorized by the manufacturer may void user's authority to operate this device.

This device complies with Part 15 of the FCC Rules. Operation is subject to the following two conditions:

- (1) This device may not cause harmful interference.
- (2) This device must accept any interference received, including interference that may cause undesired operation.

FCC Radiation Exposure Statement

The device has been evaluated to meet general RF exposure requirement.
The device can be used in portable exposure condition with out restriction.

WARNING

Warning: The product should only be used by adults and children over 14 years.

Adult supervision is required for children under 14 years.

Hinweis: Dieses Produkt ist für die Erwachsene und die Kinder ab 14 Jahren.

Die Kinder unter 14 Jahren müssen von Erwachsenen beaufsichtigt werden.

Avertissement: Ce produit est destiné aux adultes et aux enfants de plus de 14 ans.

Les enfants de moins de 14 ans doivent être surveillés par des adultes.

Avvertimento: Questo prodotto è destinato all'uso per i adulti e bambini di età superiore ai 14 anni.

I bambini di età inferiore ai 14 anni devono essere sorvegliati da un adulto.

Advertencia: Este producto es para adultos y niños mayores de 14 años.

Los niños menores de 14 años deben ser supervisados por adultos.

警告: この製品は、大人と14歳以上の子供には使用対象です。

14歳未満の子供は大人の監視が必要です。



DANGER!
Only suitable
for age 14+



Manufacturer: SHANTOU CITY CHENGHAI UDIRC TOYS CO., LTD

Address: Guangfeng Industrial Zone, Guangyi Street, Chenghai District, Shantou City, Guangdong Province, CN

Model: UD1018

MADE IN CHINA